

TOSHIBA BIPOLAR DIGITAL INTEGRATED CIRCUIT SILICON MONOLITHIC

TD62008APG, TD62008AFG

7CH DARLINGTON SINK DRIVER

The TD62008APG and TD62008AFG are high-voltage, high-current darlington drivers comprised of seven NPN darlington pairs.

All units feature integral clamp diodes for switching inductive loads and protective diodes against a negative input voltage. The TD62008APG and TD62008AFG are suitable for interfaces from plus and minus dual supply voltage systems to plus single supply voltage systems.

Applications include relay, hammer, lamp and display (LED) drivers.

Please observe the thermal conditions for use.

The suffix (G) appended to the part number represents a RoHS product.

Features

- Output current (single output) 400 mA (Max)
- High sustaining voltage output 50 V (Min)
- Output clamp diodes
- Protective diodes against a negative input voltage
- Inputs base resistor $R_{IN} = 20\text{ k}\Omega$
- Inputs compatible with 9~15 V PMOS, CMOS.
- Package type-APG : DIP-16 pin
- Package type-AFG : SOP-16 pin

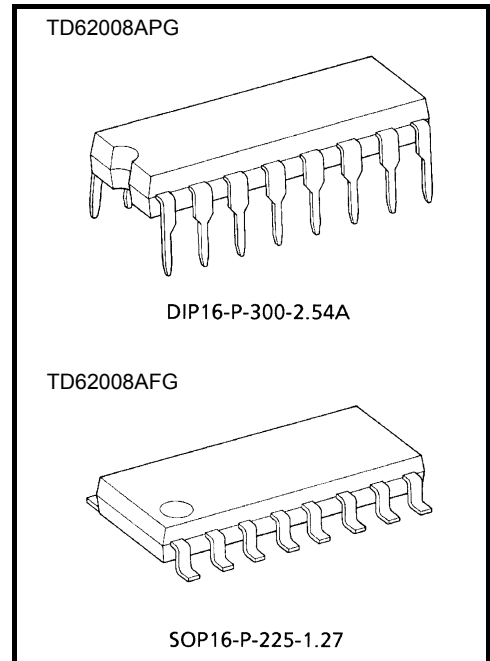

Weight
 DIP16-P-300-2.54A : 1.11 g (typ.)
 SOP16-P-225-1.27 : 0.16 g (typ.)

Pin Connection (top view)

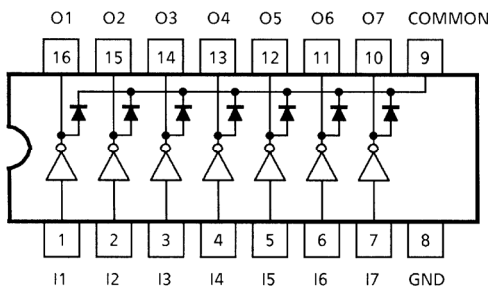

Schematics (each driver)

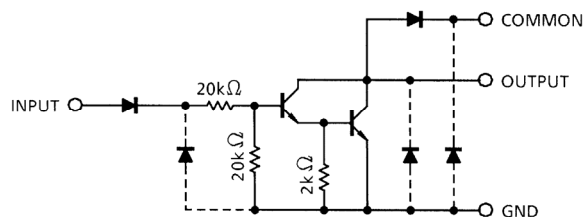

Note: The input and output parasitic diodes cannot be used as clamp diodes.

Absolute Maximum Ratings (Ta = 25°C)

CHARACTERISTIC	SYMBOL	RATING	UNIT
Output Sustaining Voltage	V _{CE (SUS)}	-0.5 ~ 50	V
Output Current	I _{OUT}	400	mA / ch
Input Voltage	V _{IN}	-40 ~ 40	V
Clamp Diode Reverse Voltage	V _R	50	V
Clamp Diode Forward Current	I _F	400	mA
Power Dissipation	APG	1.47	W
	AFG	0.625 (Note)	
Operating Temperature	T _{opr}	-40 ~ 85	°C
Storage Temperature	T _{stg}	-55 ~ 150	°C

Note: On Glass Epoxy PCB (30 × 30 × 1.6 mm Cu 50%)

Operating Conditions (Ta = -40 ~ 85°C)

CHARACTERISTIC	SYMBOL	CONDITION	MIN	TYP.	MAX	UNIT
Output Sustaining Voltage	V _{CE (SUS)}		0	—	50	V
Output Current	I _{OUT}	DC 1 Circuit, T _{pw} = 25%, Duty = 40%	0	—	400	mA
		T _{pw} = 25 ms, Duty = 10%, 7 Circuits	0	—	200	
Input Voltage	V _{IN}		-35	—	35	V
Clamp Diode Reverse Voltage	V _R		—	—	50	V
Clamp Diode Forward Current	I _F		—	—	400	mA
Power Dissipation	APG	Ta = 85°C (Note)	—	—	0.52	W
	AFG		—	—	0.325	

Note: On Glass Epoxy PCB (30 × 30 × 1.6 mm Cu 50%)

Electrical Characteristics (Ta = 25°C)

CHARACTERISTIC		SYMBOL	TEST CIR-CUIT	TEST CONDITION	MIN	TYP.	MAX	UNIT	
Output Leakage Current		I_{CEX}	1	$V_{OUT} = 50\text{ V}$	—	—	100	μA	
Collector-Emitter Saturation Voltage		$V_{CE(sat)}$	2	$I_{OUT} = 400\text{ mA}$	—	1.3	2.4	V	
				$I_{OUT} = 200\text{ mA}$	—	1.0	1.6		
Input Current	"H" Level	$I_{IN(ON)}$	4	$V_{IN} = 18\text{ V}$	—	0.85	1.8	mA	
				$V_{IN} = 35\text{ V}$	—	—	3.8		
	"L" Level	$I_{IN(OFF)}$	4	$V_{IN} = -35\text{ V}$	—	—	-20	μA	
DC Current Transfer Ratio		h_{FE}	3	$V_{CE} = 4\text{ V}, I_{OUT} = 350\text{ mA}$	1000	3000	—		
Clamp Diode Reverse Current		I_R	5	$V_R = 50\text{ V}, V_R = 35\text{ V (Type-F)}$	—	—	100	μA	
Clamp Diode Forward Voltage		V_F	6	$I_F = 400\text{ mA}$	—	1.5	2.4	V	
Turn-On Delay		t_{ON}	7	$C_L = 15\text{ pF}$	$V_{OUT} = 50\text{ V}, R_L = 156\ \Omega$	—	0.1	—	μs
Turn-Off Delay		t_{OFF}							

Test Circuit

1. I_{CEX}

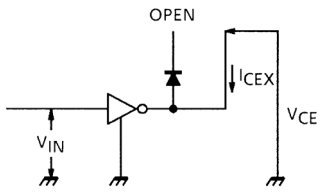

2. $V_{CE(sat)}$

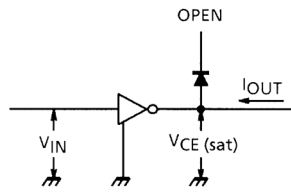

3. h_{FE}

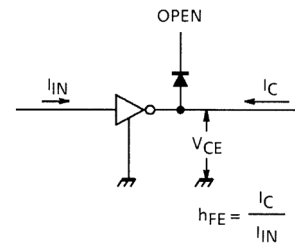

4. $I_{IN(ON)}, I_{IN(OFF)}$

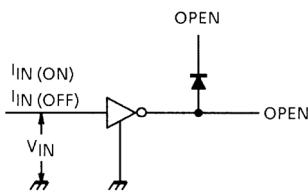

5. I_R

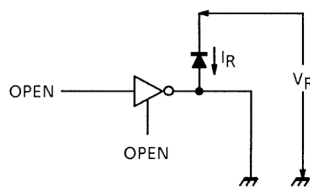

6. V_F

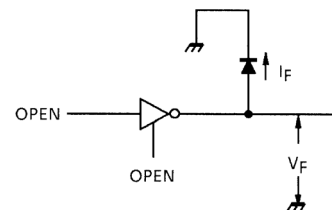

7. t_{ON}, t_{OFF}

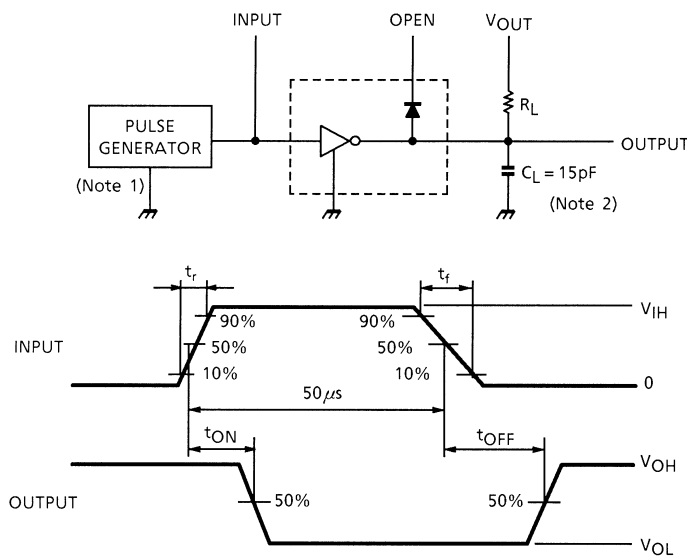

Note 1: Pulse Width 50 μ s
Duty Cycle 10%
Output Impedance 50 Ω
 $t_r \leq 5$ ns, $t_f \leq 10$ ns

Note 2: C_L includes probe and jig capacitance

Precautions for Use

This IC does not include built-in protection circuits for excess current or overvoltage.

If this IC is subjected to excess current or overvoltage, it may be destroyed.

Hence, the utmost care must be taken when systems which incorporate this IC are designed.

Utmost care is necessary in the design of the output line, COMMON and GND line since the IC may be destroyed due to short-circuit between outputs, air contamination fault, or fault by improper grounding.

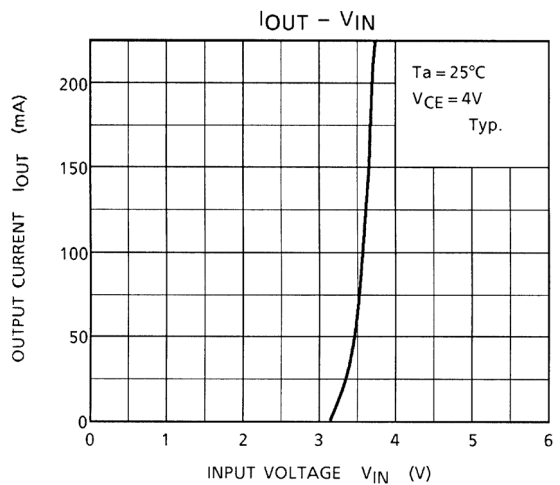
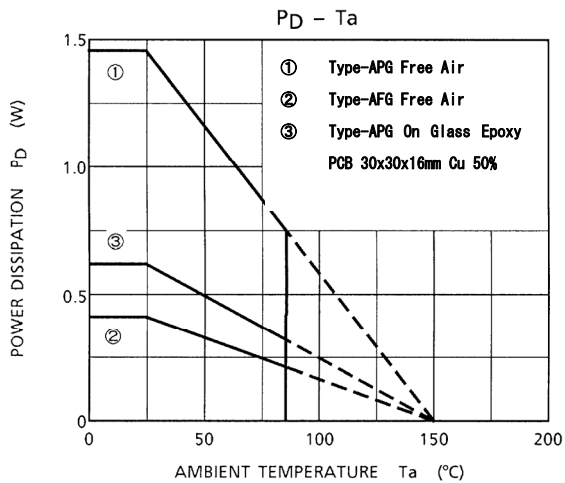
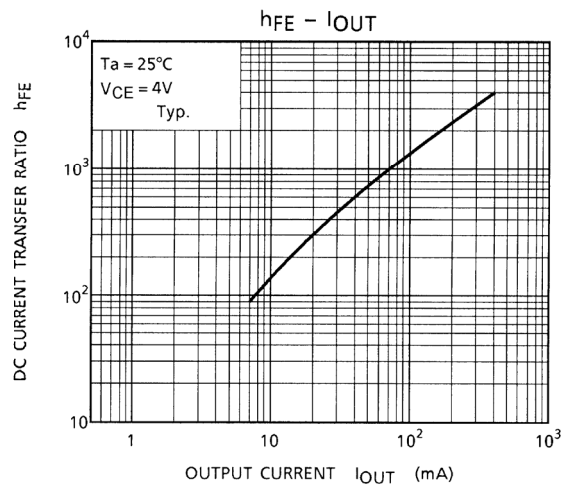
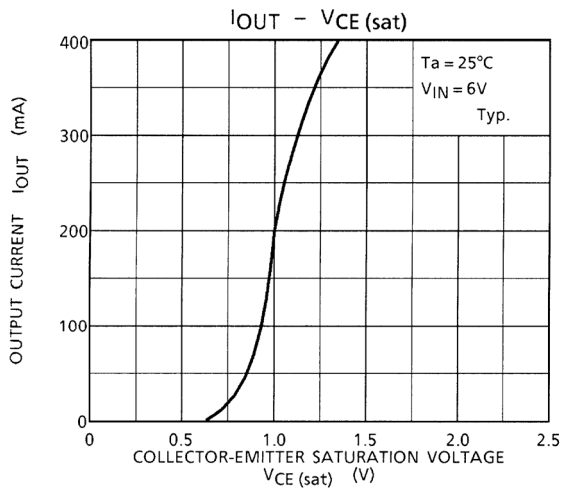
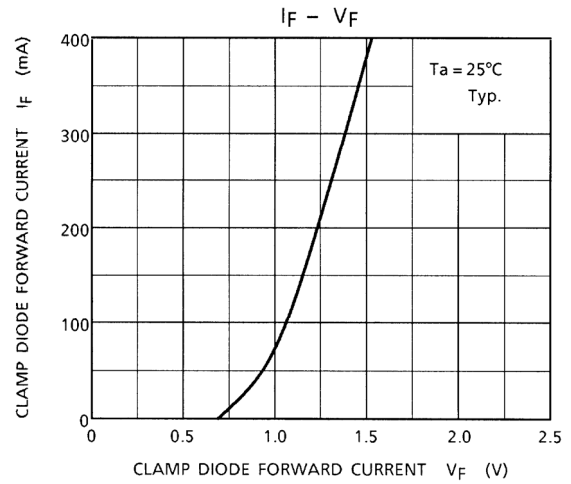
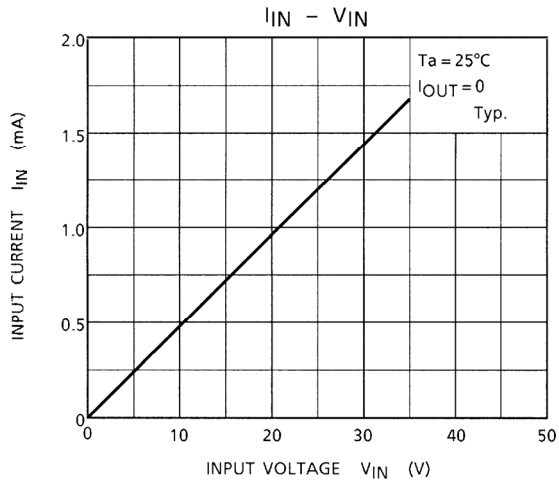

Package Dimensions

DIP16-P-300-2.54A

Unit : mm

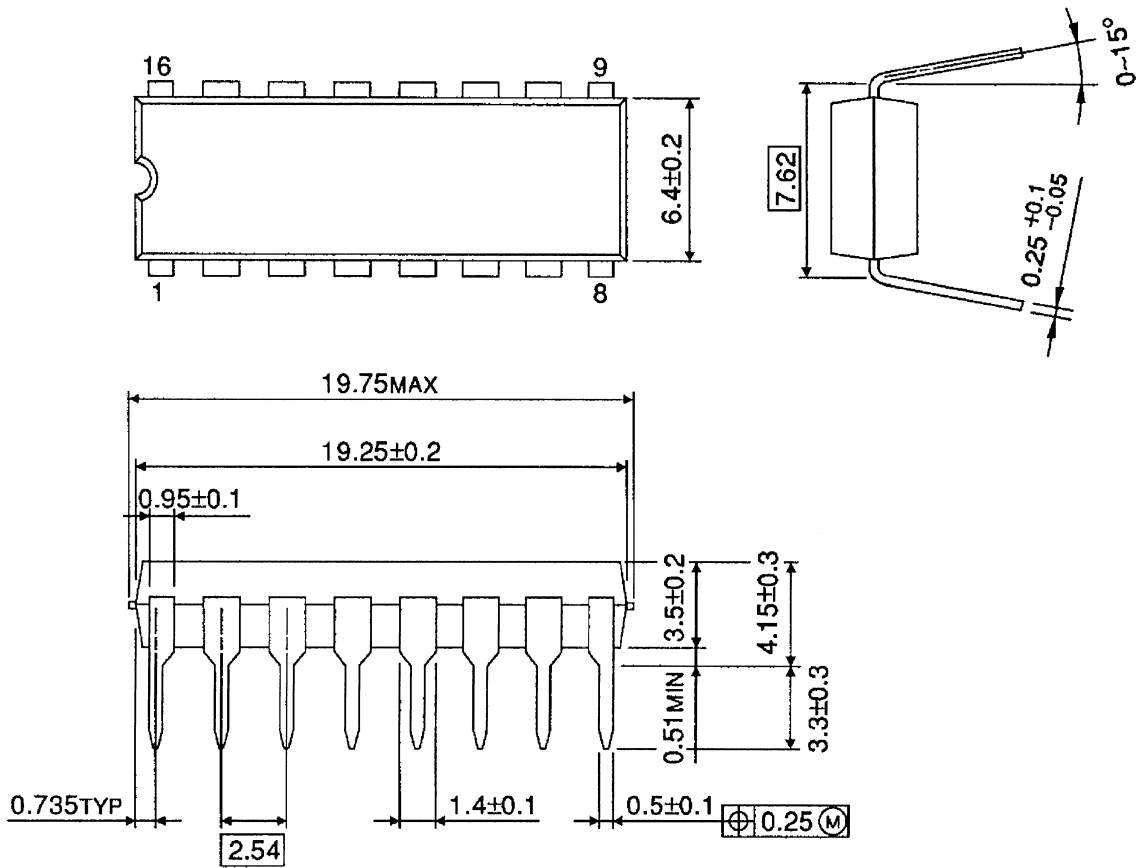

Weight: 1.11 g (Typ.)

Package Dimensions

SOP16-P-225-1.27

Unit : mm

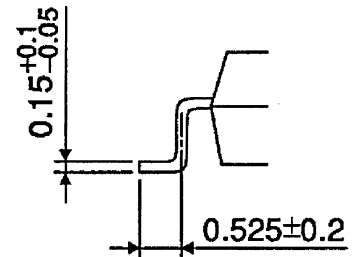
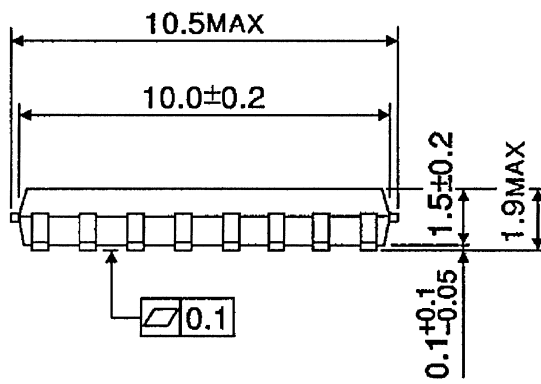
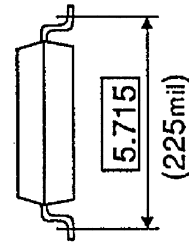
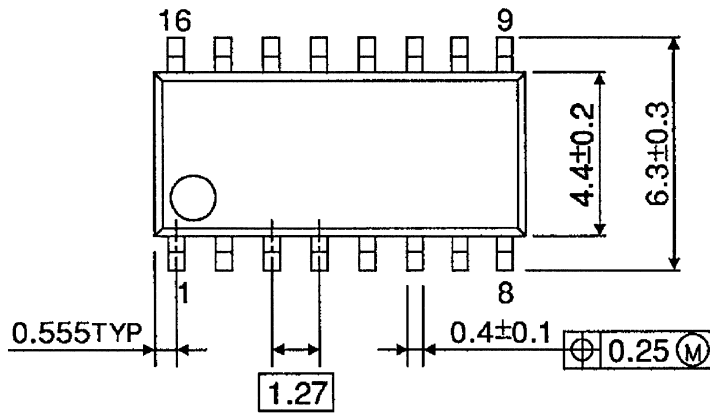

Weight: 0.16 gTyp.)

Notes on Contents

1. Equivalent Circuits

The equivalent circuit diagrams may be simplified or some parts of them may be omitted for explanatory purposes.

2. Test Circuits

Components in the test circuits are used only to obtain and confirm the device characteristics. These components and circuits are not guaranteed to prevent malfunction or failure from occurring in the application equipment.

IC Usage Considerations

Notes on Handling of ICs

- (1) The absolute maximum ratings of a semiconductor device are a set of ratings that must not be exceeded, even for a moment. Do not exceed any of these ratings.
Exceeding the rating(s) may cause breakdown, damage or deterioration of the device, and may result in injury by explosion or combustion.
- (2) Use an appropriate power supply fuse to ensure that a large current does not continuously flow in case of overcurrent and/or IC failure. The IC will fully break down when used under conditions that exceed its absolute maximum ratings, when the wiring is routed improperly or when an abnormal pulse noise occurs from the wiring or load. A breakdown could cause a large current to continuously flow and lead to smoke or ignition. To minimize the effects of the flow of a large current in case of breakdown, appropriate settings are required, such as fuse capacity, fusing time and insertion circuit location.
- (3) If your design includes an inductive load such as a motor coil, incorporate a protection circuit into the design to prevent device malfunction or breakdown caused by the current resulting from the inrush current at power ON or the negative current resulting from the back electromotive force at power OFF. IC breakdown may cause injury, smoke or ignition.
Use a stable power supply with ICs with built-in protection functions. If the power supply is unstable, the protection function may not operate, causing IC breakdown. IC breakdown may cause injury, smoke or ignition.
- (4) Do not insert devices in the wrong orientation or incorrectly.
Make sure that the positive and negative terminals of power supplies are connected properly. Otherwise, the current or power consumption may exceed the absolute maximum rating, and exceeding the rating(s) may cause breakdown, damage or deterioration of the device, and may result in injury by explosion or combustion.
In addition, do not use any device that has had current applied even once while inserted in the wrong orientation or incorrectly .
- (5) Carefully select external components such as power amps and regulators (including input and negative feedback capacitors), and load components such as speakers.
If there is a large amount of leakage current, such as from input or negative feedback condensers, the IC output DC voltage will increase. If this output voltage is connected to a speaker with a low input voltage threshold, overcurrent or IC failure could cause smoke or ignition. (The overcurrent can cause smoke or ignition from the IC itself.) In particular, please pay attention when using a Bridge Tied Load (BTL) connection type IC that inputs output DC voltage directly to a speaker.

Points to Remember on Handling of ICs

(1) Heat Radiation Design

When using an IC with a large current flow, such as in a power amp, regulator or driver, please design the device so that heat is appropriately radiated, so as not to exceed the specified junction temperature (T_j) at any time and condition. These ICs generate heat even during normal use. An inadequate IC heat radiation design can lead to decrease in IC life, deterioration of IC characteristics or IC breakdown. In addition, please design the device taking into consideration the effect of IC heat radiation on peripheral components.

(2) Back-EMF

When a motor rotates in the reverse direction, stops or slows down abruptly, current flows back to the motor's power supply due to the effect of back-EMF. If the current sink capability of the power supply is small, the device's motor power supply and output pins might be exposed to conditions beyond absolute maximum ratings. To avoid this problem, take the effect of back-EMF into consideration in system design.

About solderability, following conditions were confirmed

- Solderability

- (1) Use of Sn-37Pb solder Bath

- solder bath temperature = 230°C
 - dipping time = 5 seconds
 - the number of times = once
 - use of R-type flux

- (2) Use of Sn-3.0Ag-0.5Cu solder Bath

- solder bath temperature = 245°C
 - dipping time = 5 seconds
 - the number of times = once
 - use of R-type flux

RESTRICTIONS ON PRODUCT USE

070122EBA_R6

- The information contained herein is subject to change without notice. 021023_D
- TOSHIBA is continually working to improve the quality and reliability of its products. Nevertheless, semiconductor devices in general can malfunction or fail due to their inherent electrical sensitivity and vulnerability to physical stress. It is the responsibility of the buyer, when utilizing TOSHIBA products, to comply with the standards of safety in making a safe design for the entire system, and to avoid situations in which a malfunction or failure of such TOSHIBA products could cause loss of human life, bodily injury or damage to property.
In developing your designs, please ensure that TOSHIBA products are used within specified operating ranges as set forth in the most recent TOSHIBA products specifications. Also, please keep in mind the precautions and conditions set forth in the "Handling Guide for Semiconductor Devices," or "TOSHIBA Semiconductor Reliability Handbook" etc. 021023_A
- The TOSHIBA products listed in this document are intended for usage in general electronics applications (computer, personal equipment, office equipment, measuring equipment, industrial robotics, domestic appliances, etc.). These TOSHIBA products are neither intended nor warranted for usage in equipment that requires extraordinarily high quality and/or reliability or a malfunction or failure of which may cause loss of human life or bodily injury ("Unintended Usage"). Unintended Usage include atomic energy control instruments, airplane or spaceship instruments, transportation instruments, traffic signal instruments, combustion control instruments, medical instruments, all types of safety devices, etc. Unintended Usage of TOSHIBA products listed in this document shall be made at the customer's own risk. 021023_B
- The products described in this document shall not be used or embedded to any downstream products of which manufacture, use and/or sale are prohibited under any applicable laws and regulations. 060106_Q
- The information contained herein is presented only as a guide for the applications of our products. No responsibility is assumed by TOSHIBA for any infringements of patents or other rights of the third parties which may result from its use. No license is granted by implication or otherwise under any patents or other rights of TOSHIBA or the third parties. 070122_C
- Please use this product in compliance with all applicable laws and regulations that regulate the inclusion or use of controlled substances.
Toshiba assumes no liability for damage or losses occurring as a result of noncompliance with applicable laws and regulations. 060819_AF
- The products described in this document are subject to foreign exchange and foreign trade control laws. 060925_E